

**XiaMen city plus Innovation**  
**= XMINNOV**

**Never Forget Why We Started,  
Focus on Innovation and Move Forward**

**XMINNOV**

**Stock Code: 430525**



**Factory Overview**

## Factory Overview

Worker: 800+ / Engineers: 150 + / Sales: 30+

Office: 2400Sqm\*6floors = 14400 Sqm.

Factory: 48000 Sqm. (including old plant)



## Group Organization

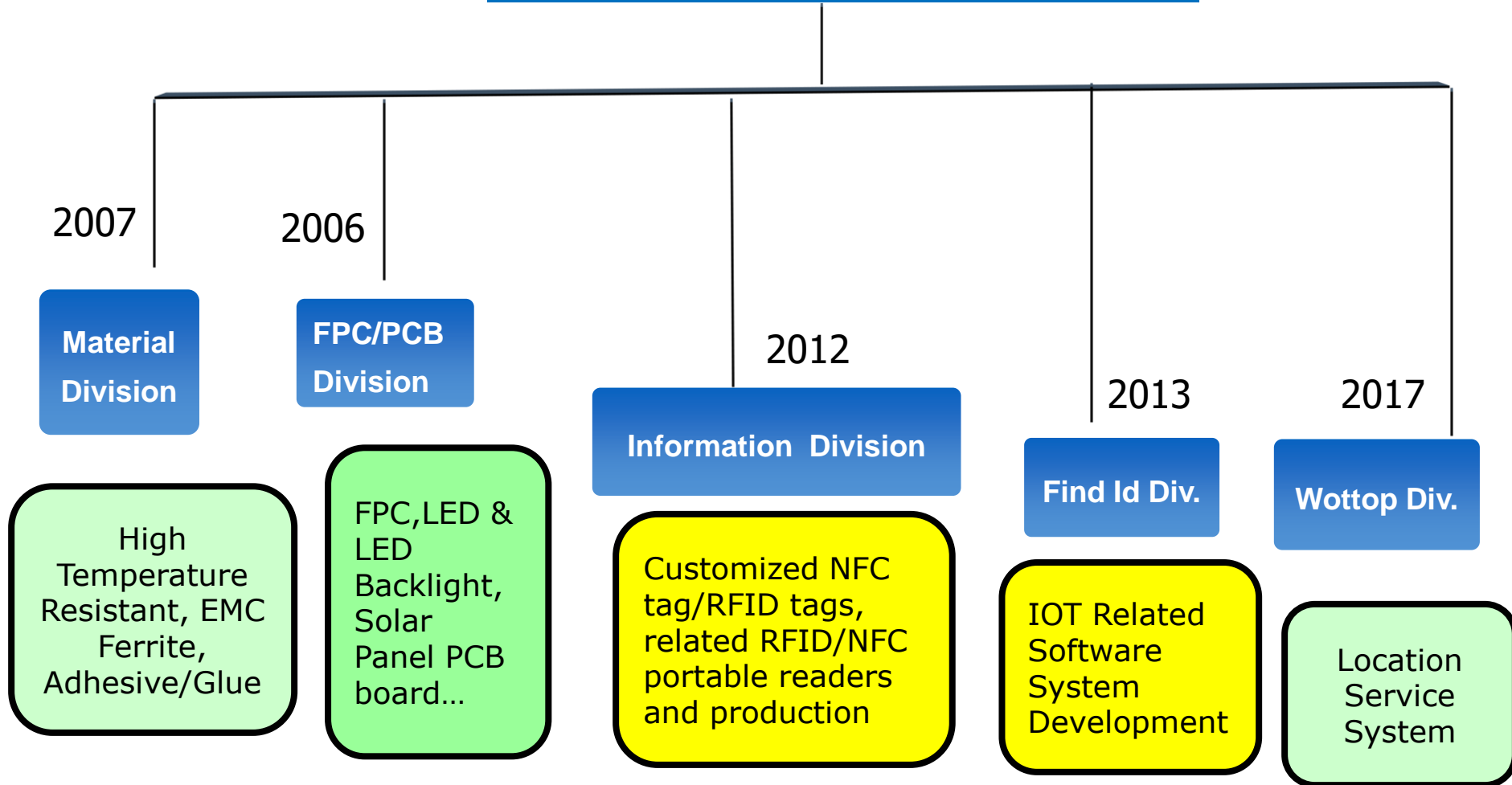



## Brief of XMINNOV

XMINNOV Group was established in 2006 in Xiamen city of China. Focusing on producing innovative RFID/NFC products basing on customized needs, has more than 5 subsidiary-companies whom are holding different parts of business in supporting in between, such as raw materials manufacturing of PI/PET/Paper/glue ; PCB/FPC/Antenna Manufacturing; Digital Devices/Hardware; Software Development; Automatic Production Line Manufacturing and so on

With excellent R & D technical team, Complete Test Instrument and Production line, ISO Specific Quality Management System, which helps XMINNOV provide one stop service for all the needs, basing on their rich experience, they have more than 100 intellectual property rights of RFID, NFC and related Equipment and increasing of more than 20 patents each year, their products was patented & exported to many countries such as USA, Japan, Korea, Turkey, Brazil, Peru, Serbia, France, Germany, Malaysia, India, Philippines, Italy, Mexico and so on.

## Authoritative Membership

- Certified as “Xiamen RFID/NFC Tag Engineering Technology & Research Center”
- Published “National GB Standard of RFID Pallet Identification” in China.



RFID创新部落



- Certified as Fujian province "Hundred Talents Plan" talent Innovation Enterprise
- Certified as National High-tech Enterprises
- Certified as Xiamen city Innovative Demonstration Enterprises
- Certified as Xiamen Expert, Specialized and Peculiar new Enterprises

## Professional Team

- Digital Circuit Design Engineer 5+
- Analog Circuit Design Engineer 28+
- Layout Engineer 15+
- RF Design Engineer 14+
- Firmware Engineer 5+
- PC/Android/iOS Software Engineer 8+
- Molding Engineer 11+
- Structure Design Engineer 4+
- Process Optimization Engineer 4+
- Tooling Engineer 6+
- Qualifying/Test Engineer 10+
- Equipment Maintenance Engineer 15+

All products XMINNOV produced are connected to their patents including RFID & NFC, NFC parts of intellectual property right was issued on March 14, 2013, consider International PCT, their patents were available not only China, but also United States, South Korea and Japan and so on.

PATENT COOPERATION TREATY  
**PCT**  
INTERNATIONAL PRELIMINARY REPORT ON PATENTABILITY  
(Chapter I of the Patent Cooperation Treaty)  
(PCT Rule 41bis)

Applicant's or agent's file reference	FOR FURTHER ACTION		See item 4 below
PCT/US2012/02562	International filing date (day/month/year)	Priority date (day/month/year)	
	14 March 2012 (14.03.2012)	07 August 2012 (07.08.2012)	
International Patent Classification (IPC edition and/or other edition indicated)	See relevant information in Form PCT/ISA/227		
Applicant: XIAMEN INNOV ELECTRONICS CO., LTD			

- This international preliminary report on patentability (Chapter I) is issued by the International Bureau on behalf of the International Searching Authority under Rule 44A(1)(a).
- This REPORT consists of a total of 6 sheets, including this cover sheet.  
In the attached sheets, any reference to the written opinion of the International Searching Authority should be read as a reference to the international preliminary report on patentability (Chapter I) instead.
- This report contains indications relating to the following items:
 

<input checked="" type="checkbox"/>	Box No. I	Basis of the report
<input checked="" type="checkbox"/>	Box No. II	Priority
<input checked="" type="checkbox"/>	Box No. III	Non-establishment of opinion with regard to novelty, inventive step and industrial applicability
<input type="checkbox"/>	Box No. IV	Lack of unity of invention
<input checked="" type="checkbox"/>	Box No. V	Reasoned statement under Article 35(2) with regard to novelty, inventive step or industrial applicability, citations and explanations supporting such statement
<input type="checkbox"/>	Box No. VI	Certain documents cited
<input type="checkbox"/>	Box No. VII	Certain defects in the international application
<input type="checkbox"/>	Box No. VIII	Certain observations on the international application
- The International Bureau will communicate this report to designated Offices (in accordance with Rules 40bis(3) and 52bis.1) but not, except where the applicant makes an express request under Article 23(2), before the expiration of 30 months from the priority date (Rule 44bis.2).

证书号第 1004283 号

## 发明专利证书

发 明 名 称: 具有旋转转移层的高频率RFID电子标签及其制备方法

发 明 人: 李文强

专 利 号: ZL 2012 1 0270001.0

专 利 申 请 日: 2012 年 08 月 07 日

专 利 权 人: 厦门英诺诺电子科技有限公司

授 权 告 白 日: 2016 年 01 月 20 日

本发明专利说明书依照中华人民共和国专利法进行审查, 决定授予专利权。该发明专利权自公告之日起生效。  
本专利的专利期限为二十年, 自申请日起算, 专利权人应当依照本法及其实施细则规定的年费, 在本专利的有效期内每年 8 月 31 日前缴纳。未按规定缴纳年费的, 专利权自应当缴纳年费期满之日起终止。  
专利证书记载专利权登记的法律状况, 专利权的转移、质押、无效、终止、被宣告专利权人的姓名或者名称、国籍、地址变更等事项记载在专利登记簿上。

局长  
申长明

2016 年 01 月 20 日

US997185582

(12) **United States Patent**  
Li

(11) Patent No.: **US 9,218,558 B2**  
(15) Date of Patent: **Dec. 22, 2015**

(54) **HIGH-FREQUENCY FRAGILE RFID ELECTRONIC TAG WITH ANTI-TRANSFER FUNCTION AND PREPARATION METHOD THEREOF**

(71) Applicant: **XIAMEN INNOV ELECTRONICS CO., LTD.**, Xiamen (CN)

(72) Inventor: **Wenqiang Li**, Xiamen (CN)

(73) Assignee: **XIAMEN INNOV ELECTRONICS TECH CO., LTD.**, Xiamen (CN)

(57) **Abstract**  
Subject to any disclaimer, the term of this patent is extended by adjustment under 35 U.S.C. 156(a) by 8 days.

(21) Appl. No.: **1404907**

(22) PCT Filed: **Mar. 14, 2012**

(60) PCT No.: **PCT/US2012/02562**  
§ 121(a)(1)  
(25) Date: **Mar. 14, 2014**

(67) PCT Pub. No.: **WO2014/023699**  
PCT Pub. Date: **Feb. 13, 2014**

(69) **Prior Publication Data**  
US 2015024666 A1 Sep. 3, 2015

(30) **Foreign Application Priority Data**  
Aug. 7, 2012 (CN) **2012 1 0270001**

(51) **Int. Cl.**  
**G06K 7/80** (2006:01)  
**G06A 1/03** (2006:01)  
**G06A 1/07** (2006:01)

(52) **U.S. Cl.**  
**G06A 1/03** (2013:01); **G06A 1/07** (2013:01); **IME, 2012** (2013:01); **IME, 2014** (2013:01)

(56) **Field of Classification Search**  
USPC ..... 235025, 343732  
See application file for complete search & history.

(58) **References Cited**  
U.S. PATENT DOCUMENTS  
2006/049995 A1 \* 2006, Tsai et al. 2010/0270001 01/14, 2010, Arora et al. 2010/09 \* cited by examiner

Primary Examiner — Daniel Hsue  
(74) Attorney Agent or Firm — **Stuart B. LLC**

(57) **ABSTRACT**  
The tag comprises a bearing substrate, a first adhesive layer, a resin film, an etching antenna layer, a chip, a first insulating layer, a conductive circuit layer, a second adhesive layer, and a pattern-bearing layer. The resin film is disposed between the bearing substrate and the etching antenna layer. The etching antenna layer is etched by copper foil or aluminum foil. The conductive circuit layer and the etching antenna layer are combined to construct a compact high-frequency antenna of the fragile RFID electronic tag. The conductive circuit layer includes a communication antenna of a person wear on the etching antenna layer. The first insulating layer is disposed between the conductive circuit layer and the etching antenna layer. The chip is connected to the etching antenna layer, the first insulating layer, and the chip are combined to construct a secure assembly. The pattern-bearing layer is adhered to the other side of the core substrate to be the second adhesive layer.

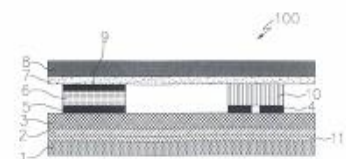





# Quality & Management System

ISO14001;ISO9001; ISO27001;ROHS, as well as customized certification & annual technique audit by customers



## 检测报告 Test Report

报告编号: SCL01H051828003E 第 1 页 共 6 页  
 Report No: SCL01H051828003E Page 1 of 6

申请单位: 厦门英诺尔信息科技有限公司  
 Applicant: XIAMEN INNNOV INFORMATION TECHNOLOGY CO.,LTD.  
 地址: 厦门火炬翔安产业园区翔虹路1号  
 Address: XIANGHONG ROAD ON THE 1ST,XIANG'AN TORCH INDUSTRIAL DISTRICT, XIAMEN

以下测试之样品及样品信息由申请者提供并确认  
 The following sample(s) and sample information was/were submitted and identified by/on the behalf of the client

样品名称	超高频电子标签 (铝蚀刻)
Sample Name	UHF RFID TAG (Aluminum Etched)
样品颜色	彩色
Color	
样品接收日期	2015.06.23
Sample Received Date	Jun. 23, 2015
样品检测日期	2015.06.23-2015.06.25
Testing Period	Jun. 23, 2015 to Jun. 25, 2015

检测要求: 根据客户要求, 对所提交样品中的铅(Pb), 镉(Cd), 汞(Hg), 六价铬(Cr(VI)), 多溴联苯(PBBs), 多溴二苯醚(PBDEs)进行检测。  
 As specified by client, to test Lead (Pb), Cadmium (Cd), Mercury (Hg), Hexavalent Chromium(Cr(VI)), Polybrominated Biphenyl(PBBs), Polybrominated Diphenyl Ethers(PBDEs) in the submitted sample(s).

检测方法: 见下文。  
 Test Method/Test Result(s): Please refer to the following page(s).

主检: Mike  
 Tested by: Mike  
 批准: Danyu Liu  
 CTI 华测检测

审核: Danna  
 Reviewed by: Danna  
 日期: 2015.06.25  
 Date:

Danny Liu  
 Technical Manager  
 华测检测股份有限公司  
 Hoegwe Industrial Zone, Bao an 70 District, Shenzhen, Guangdong, China

No. R185011977

\* The list of IQNet partners is valid at the date of issue of this certificate. Updated information is available under: www.iqnet-certification.com

\* The list of IQNet partners is valid at the date of issue of this certificate. Updated information is available under: www.iqnet-certification.com

## Customer QC Flow Chart

We provide Quality Inspection Report for each piece of RFID tag & NFC tag according to customer request, in order to be more efficiency in later uploading.





Requirement



Simulation

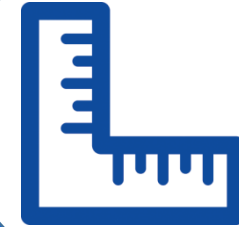

Measure  
& Verify



Analyze & Design

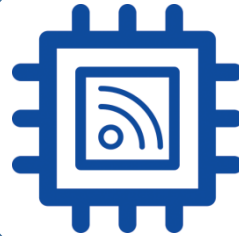

Sample Preparation



Sealed Sample  
& SPEC Releasing

One-stop service started from development, antenna design, raw material, etching, flip-chip, die cutting, encoding to QC the finished products

All production line equipped with robots or automatic parts in order to avoid operator's mistake.



# Complete Production Line In House

## Production FlowChart



1. Raw Material



2. Antenna



3. Flip Chip



4. Lamination



5. Die Cutting



6. QC Verification



7. Encoding  
(including barcode  
Serial printing)



8. QC

## Workflow For Conduct Raw Material

**Raw  
substrate**

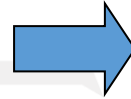

**Coating film**



**Small tape of Material  
ready for next use**

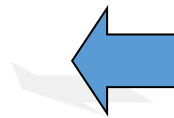

**Spitting Line**

## Antenna Workflow – Quickest Lead Time Expected

**Core technologies:** film exposure, Roll To Roll etching technology, realize RFID antenna precision, smooth antenna, no obvious jagged shapes.

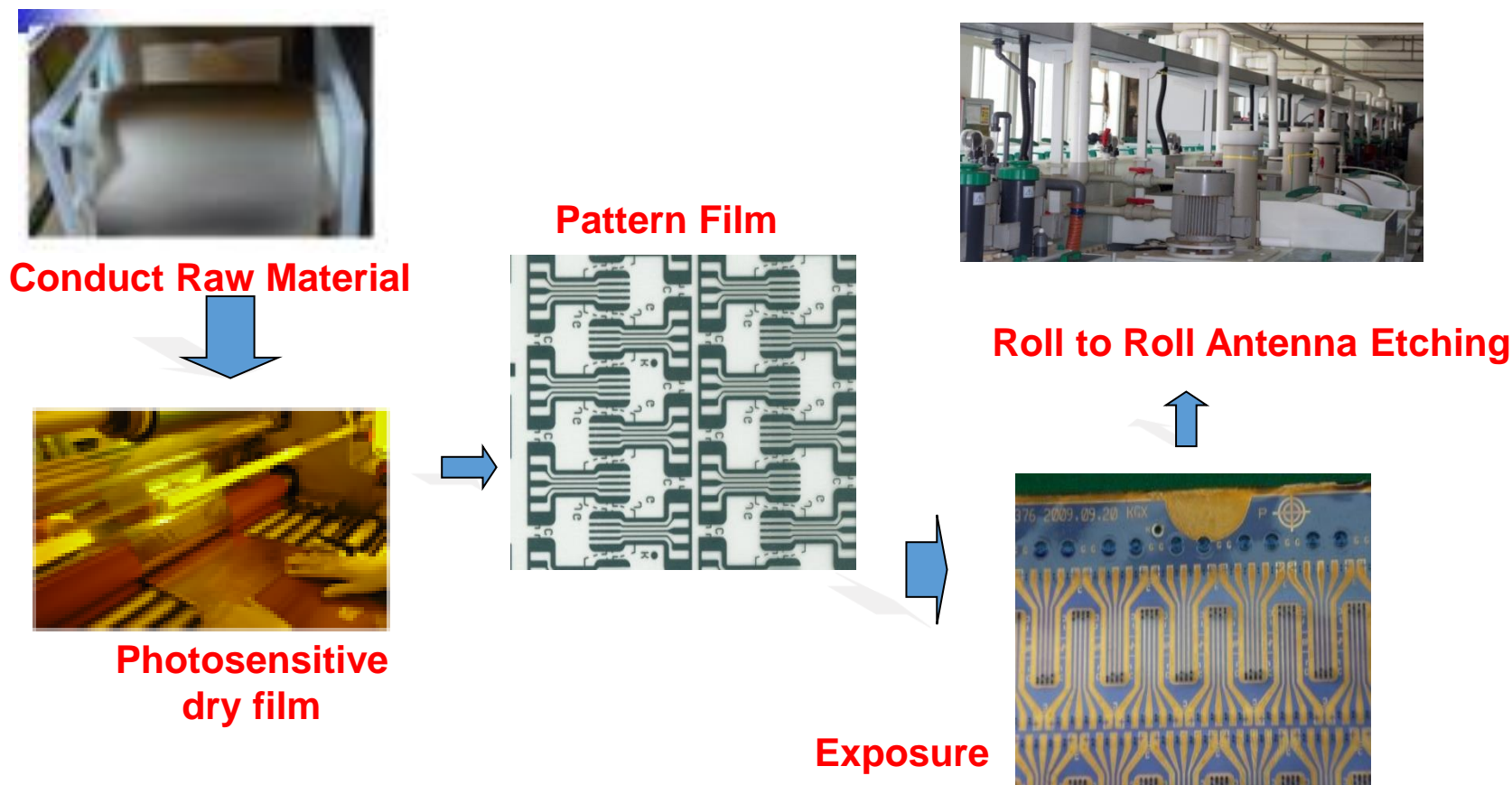



## Label Production Workflow



**RFID Inlay**

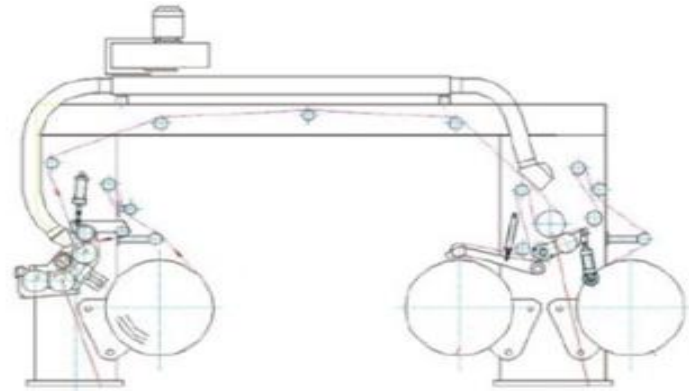
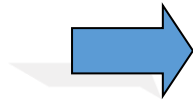

**Converting/Lamination**

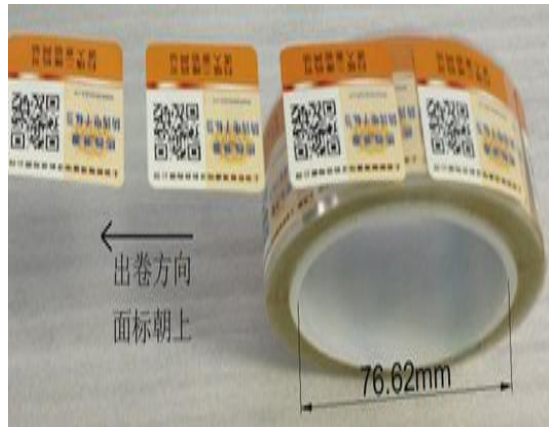

**Finished Label get ready for next step**

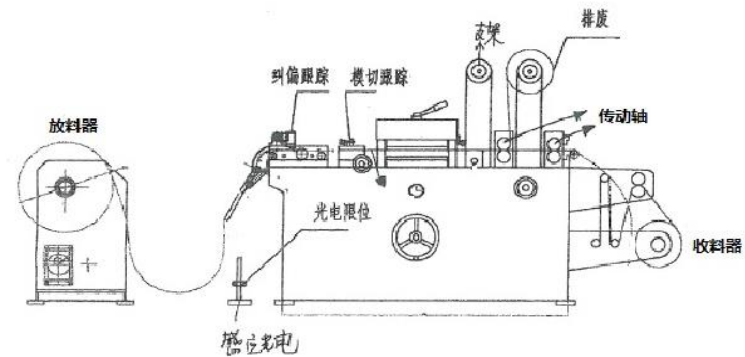
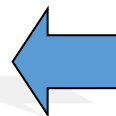

**Die – Cutting procedure**

# Quality Management Inspection System

## Excellent Qualify Solution

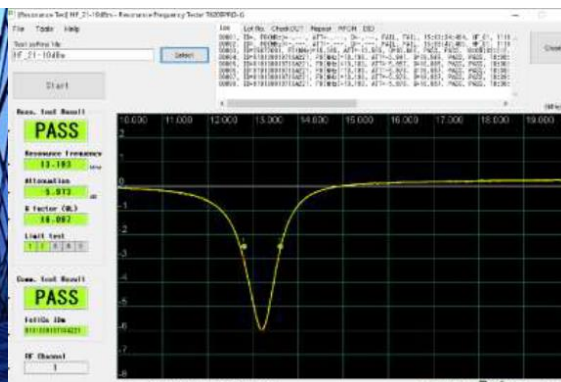
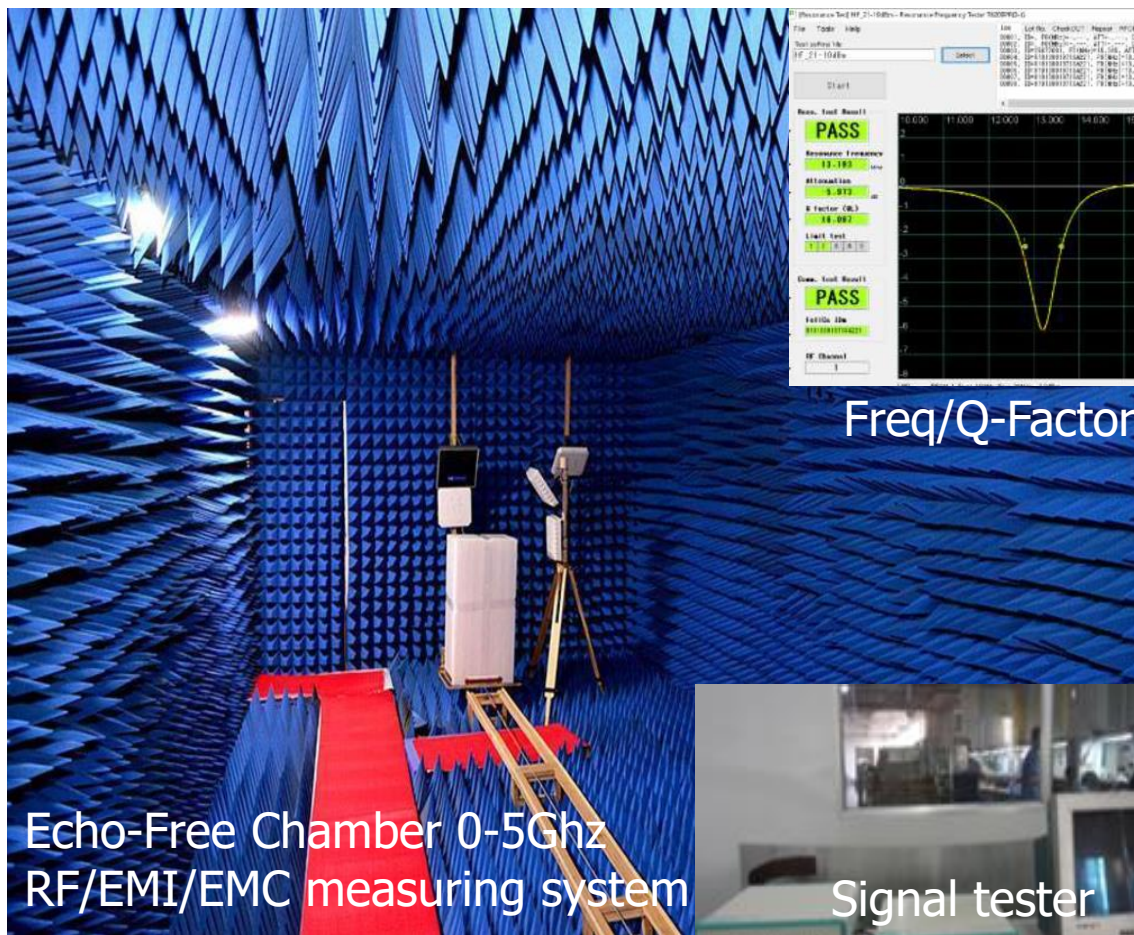

Freq/Q-Factor



Signal tester



RoHS Tester

## Inspection System



ROHS tester



Spectrum analyzer



Metallographic microscope



High-low temperature chamber



Network analyzer



Chemical laboratory

## Inspection System

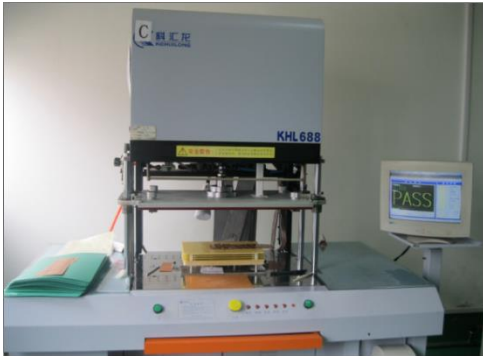

O/S test



2D Flat Microscope



Metalloscope



X-ray thickness Detector



High/low temperature Chamber



Bending Test

## Open-Short Test

**Test Kit  
fixed at QC  
machine**

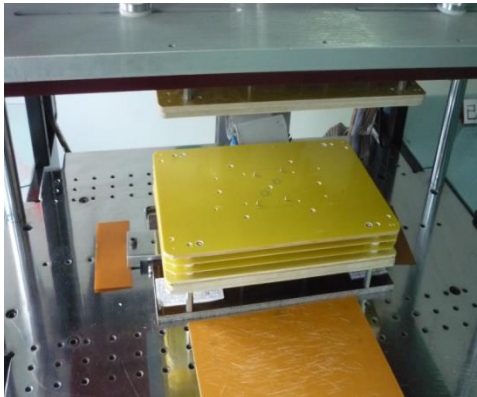

**Put FPC board  
get ready for test**

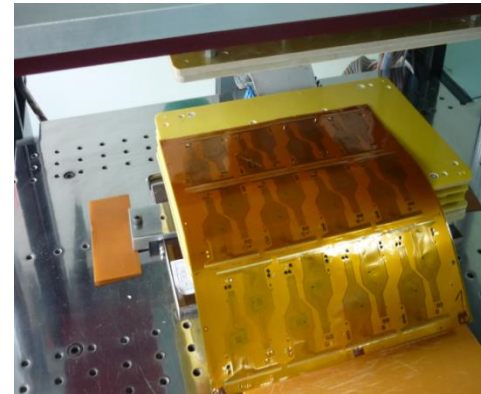

**OK - PASS  
NG - FAIL**

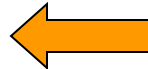
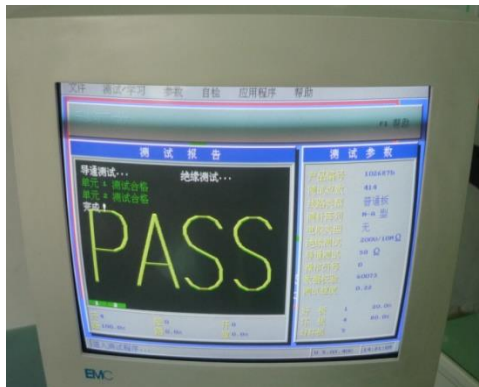

**Pull down tool kit  
To touch FPC board  
for open-short test**

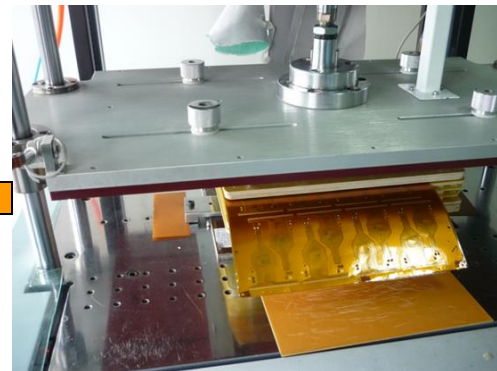



Oscilloscope 示波器



Burn in Test 老化测试

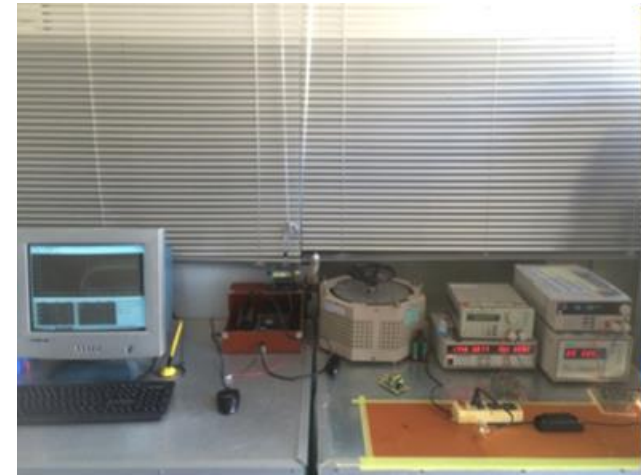

Temperature Identifying  
Control Instrument/温度打点仪

## Release ISO Quality Standard from Anechoic Chamber basing on International EPCglobal standard

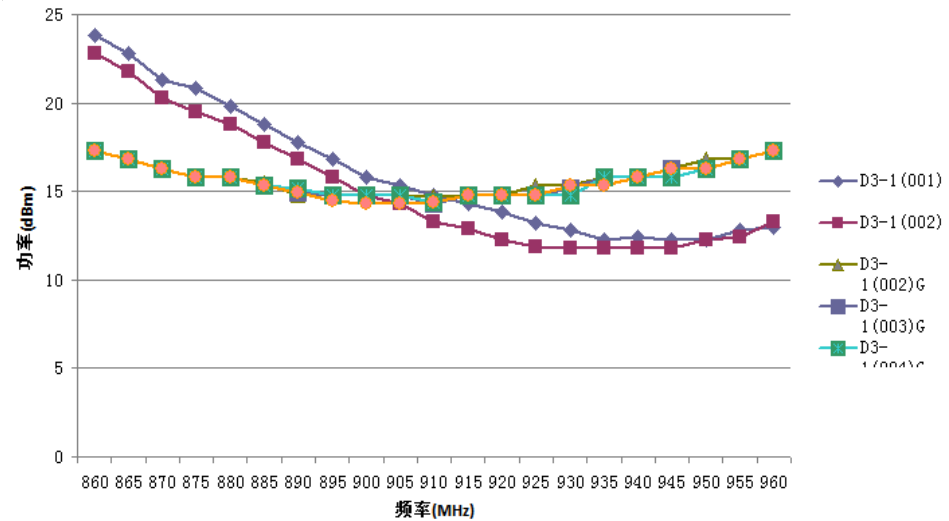
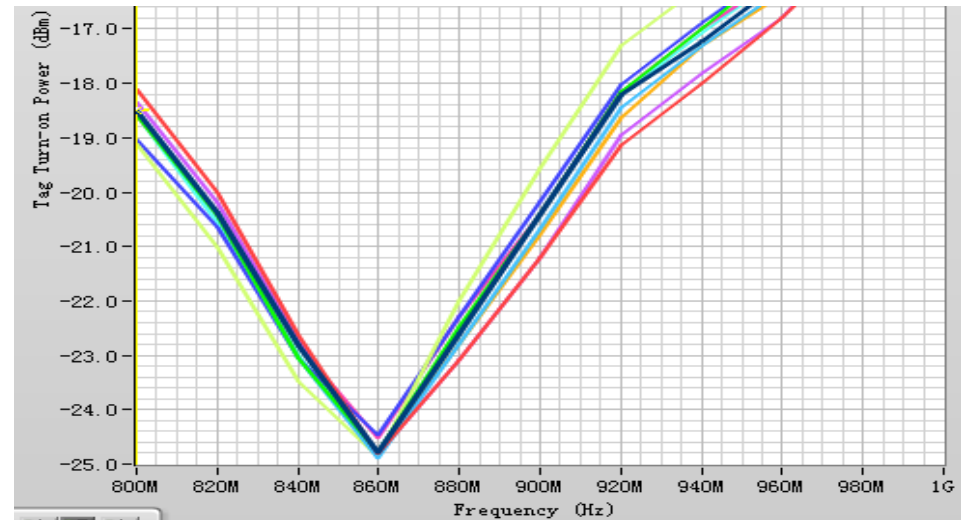

Specify Standard for Encoding machine which is equal to ISO standard in both of Real and AirFree condition



Inspect RFID/NFC tags piece by piece, Ink mark for rejection or removing rejection

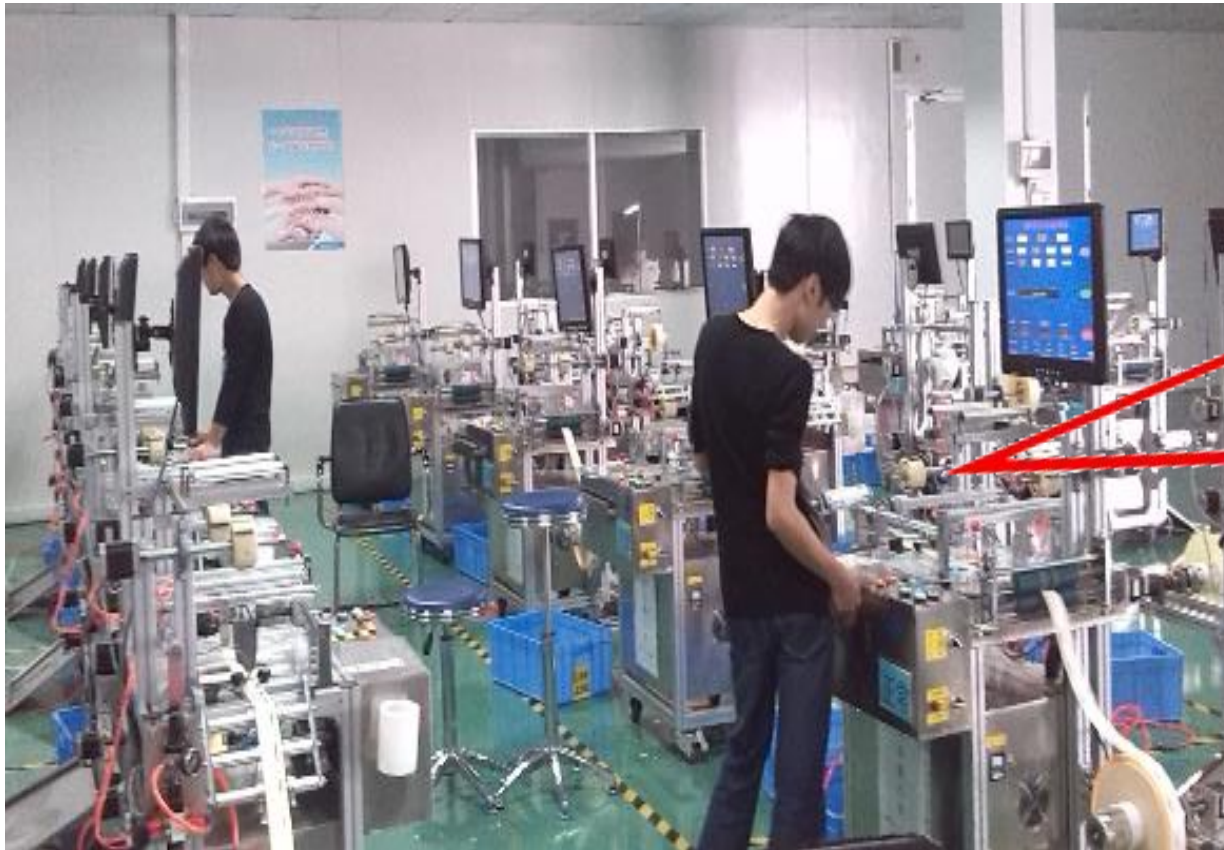

## Global Market

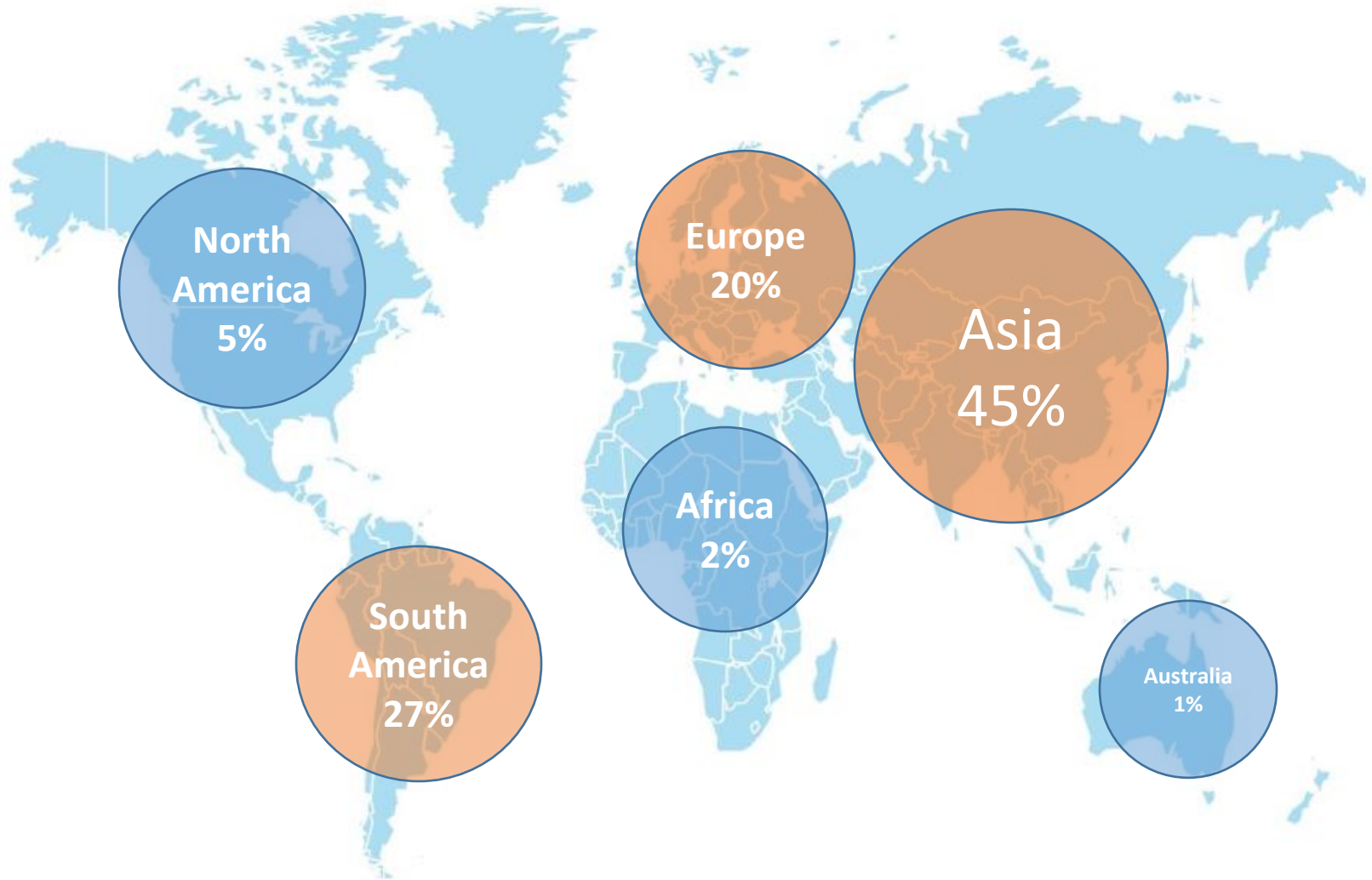

**XMINNOV**

# Partner Customers

ASSA ABLOY  
**HID**

**Canon**

  
**HYUNDAI**

*Coca-Cola*

**SKYLANDERS**  
SWAP FORCE

**KIA**

 **Alibaba**

**Carlsberg**

**Touch  
'n GO**

  
**Shell**

  
**TATA**

 **Heineken**<sup>®</sup>

**paytm**

**1. Value-Added**

**2. Solve Problems**

**3. All Win**

## Thank You!



Welcome to contact us for more information

VP/CTO: John Lee

Email: [JohnLee@xminnov.com](mailto:JohnLee@xminnov.com)

Tel: +86-592-3365735

C.P/Wechat/WhatsApp: +86-13606915775